

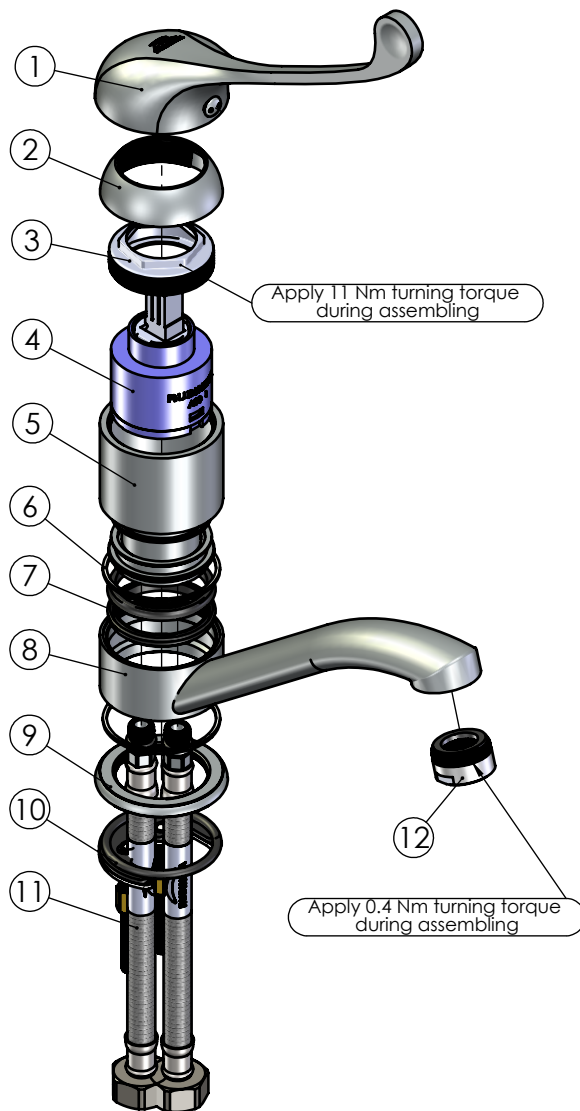

RUBINETA

Product name: **Faucet P-19 MEDIC**
Product Code: **P90005**



ITEM NO.	PART CODE	NAME	QUANTITY
1	631015	Cartridge handle Medic	1
2	636207	Cartridge cap 49mm	1
3	636302	Stainless steel cartridge nut M42x1.25	1
4	634005	Cartridge 40 mm	1
5	635056	Body, P-20	1
6	632047	Teflon ring 43x1.3	2
7	632003	Loop seal V -shape	2
8	635551	Spout, P-19	1
9	636005	Base nut, P-20	1
10	636913	Fixing set P-20	1
11	618040	Faucet hose G1/2'-M10x1 400 mm	2
12	636705	Aerator M24x1	1